

HDX WILL CBCT SERIES

DRIVEN BY INTELLIGENCE.
DEFINED BY CLARITY.

DENTRImax



ECO 



The Evolution of Vision Powered by Advanced Algorithms

Experience clarity that makes diagnosis effortless. We've continuously refined the imaging engine behind our scanners to reveal the finest anatomical details. See how HDX WILL's intelligent technology eliminates visual noise, scatter, and beam hardening—bringing crystal-clear insights to your daily practice.

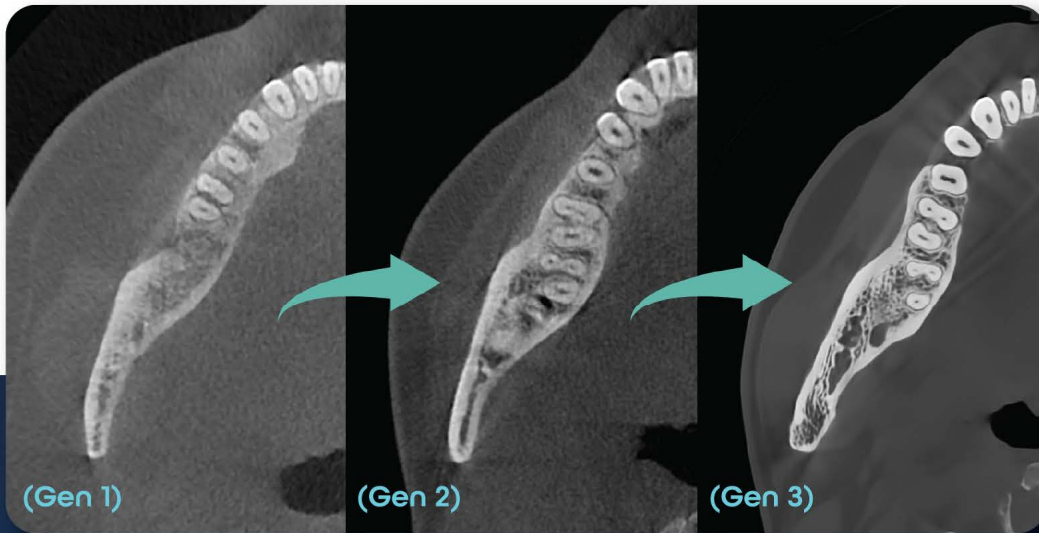

Unmatched Clarity Across the Full FOV

Experience fine anatomical details even at the maximum 18 x 16.5 cm field of view, powered by our advanced reconstruction engine.



70 µm Voxel Precision for Endodontics

Visualize the most complex root canal structures with ultra-fine **70 µm** voxel imaging for absolute diagnostic confidence.

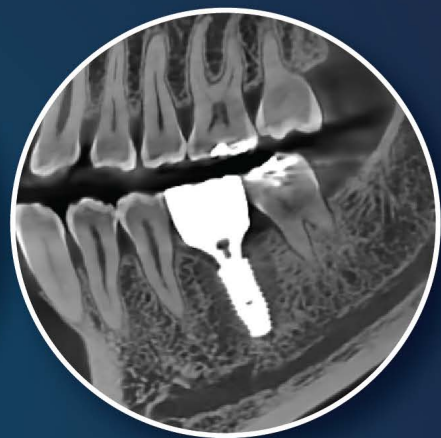

Next-Gen MAR Algorithm

Significantly minimizes scatter and beam hardening, ensuring crystal-clear, minimal-artifact images near implants and prosthetics.



eco

The wide 16 x 9 cm FOV captures the entire dentition, TMJ, and facial structures in a single scan. Tailor your focus with flexible options ranging from 3 x 3 cm to 16 x 9 cm.



16 x 9 cm
Dental Arch mode



16 x 9 cm
Nose / Ear Mode



10 x 8 cm
Child Mode



Free FOV
(3 x 3 cm - 12 x 9 cm)



Model CT scan

DENTRI^{max}

Maximize your diagnostic capabilities with an expansive 18 x 16.5 cm FOV. From focused 3 x 3 cm scans to comprehensive maxillofacial views, Dentri Max offers the versatility your practice demands.



18 x 16.5 cm
Dental Arch mode



16 x 9 cm
Dental Arch mode



16 x 9 cm
Nose / Ear Mode



10 x 8 cm
Child Mode



Free FOV
(3 x 3 cm - 12 x 9 cm)



Model CT scan



Low Radiation Dose

Powered by HDX WILL's Adaptive Exposure Control (AEC) and advanced imaging engine, you can achieve superior diagnostic clarity at a fraction of the standard dose.

Adaptive Exposure Control(AEC)

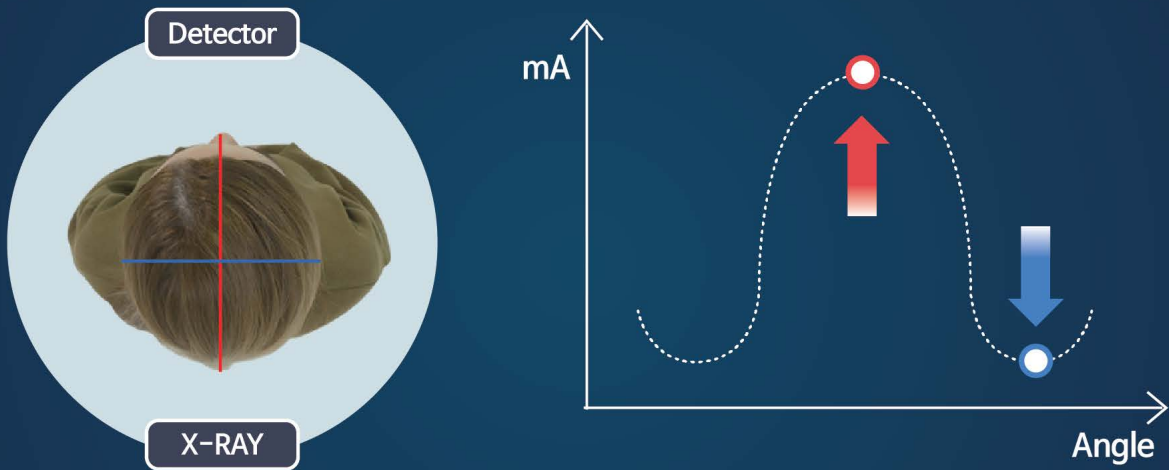

AEC technology automatically optimizes radiation levels based on patient anatomy and tissue thickness.

Standard PANO

CBCT scans at up to 50% of the dose of panoramic imaging
*16 x 9 cm FOV with Low Dose & AEC ON

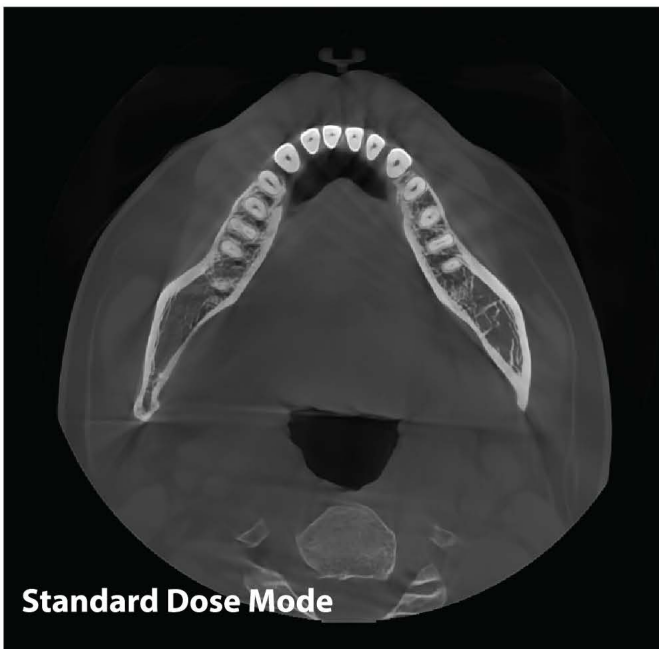

Automate Your Workflow

01

FMX Extraction from Panorama

Effortlessly generate a complete Full Mouth Series (FMX) from a single panoramic scan.

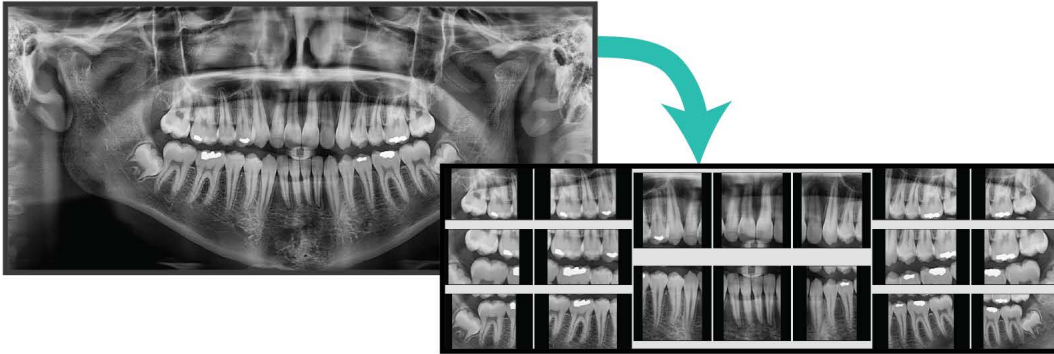

02

Model Scan: Automatic STL creation

Automatically generate STL and CBCT DICOM files without the need for extra software.



03

Auto Landmark Tracing

Spend less time at the computer and more time focused on your patients with Auto Landmark Tracing.

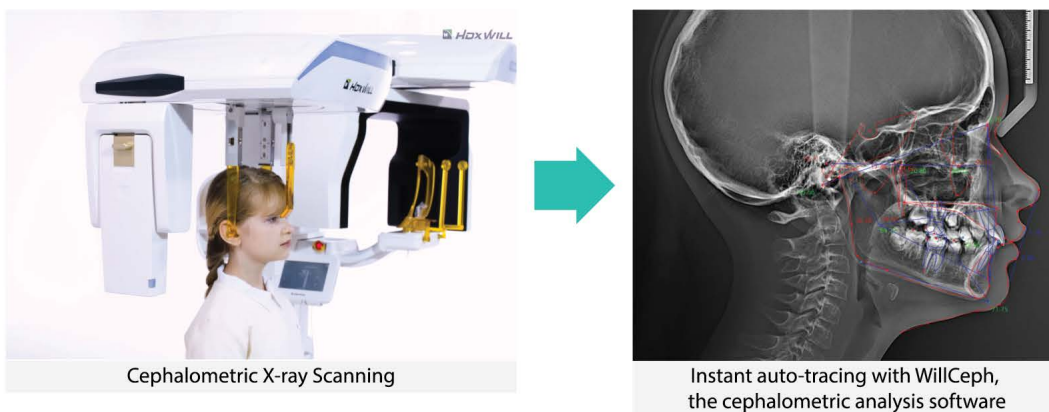

Diagnostic Excellence

Digital Implant Planning

Unparalleled image quality combined with comprehensive software tools for precise, predictable implant planning.

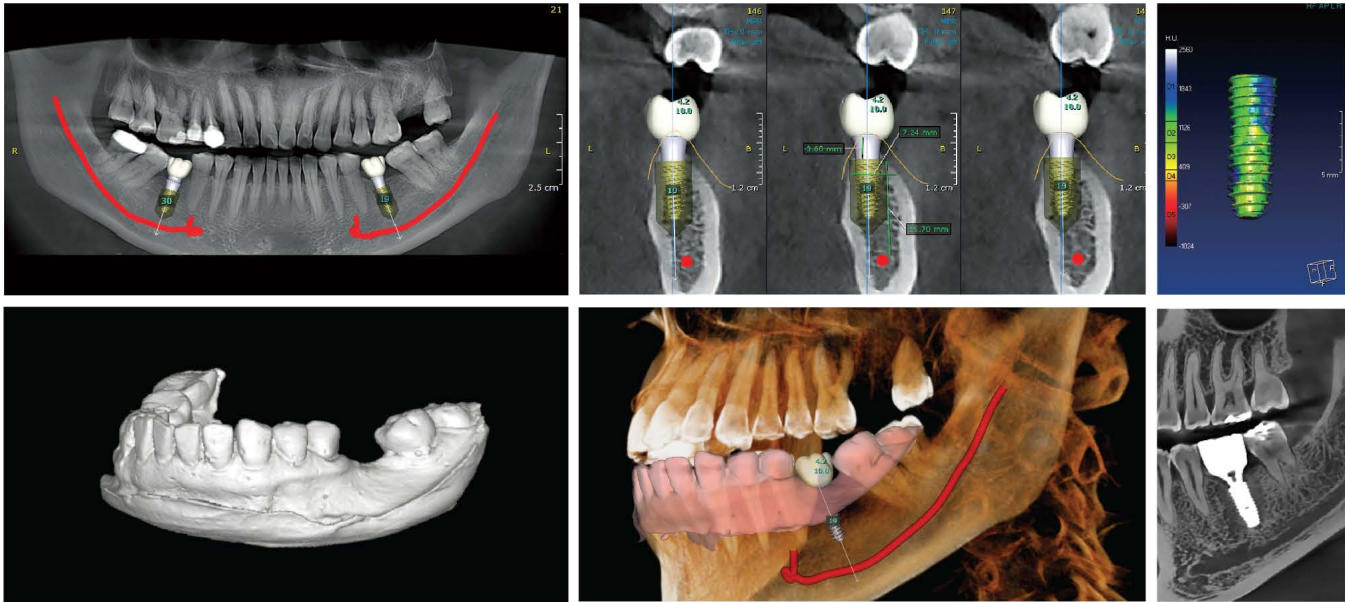

Oral Surgery

Confidently navigate complex surgeries with high-definition views of impacted teeth and vital nerves.

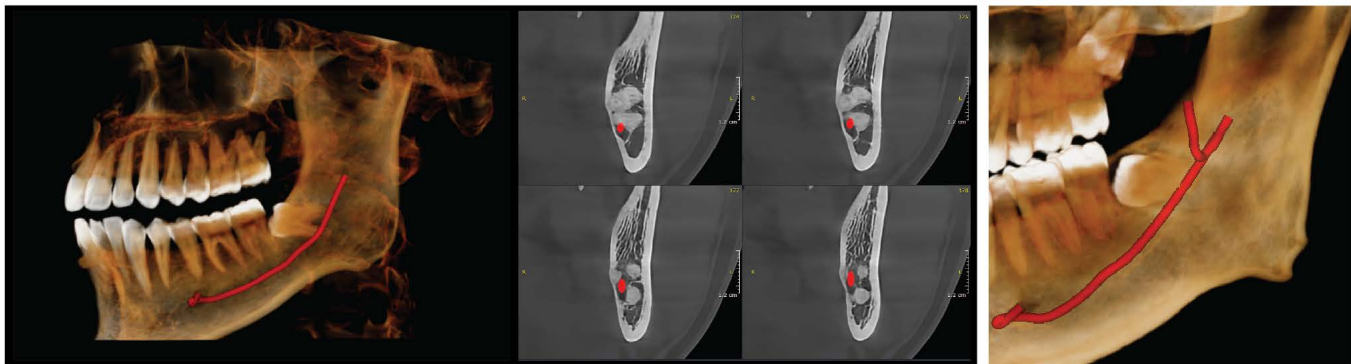

Endodontics

Ultra-high resolution imaging reveals intricate root canal morphology, micro-fractures, and hidden lesions with absolute clarity.

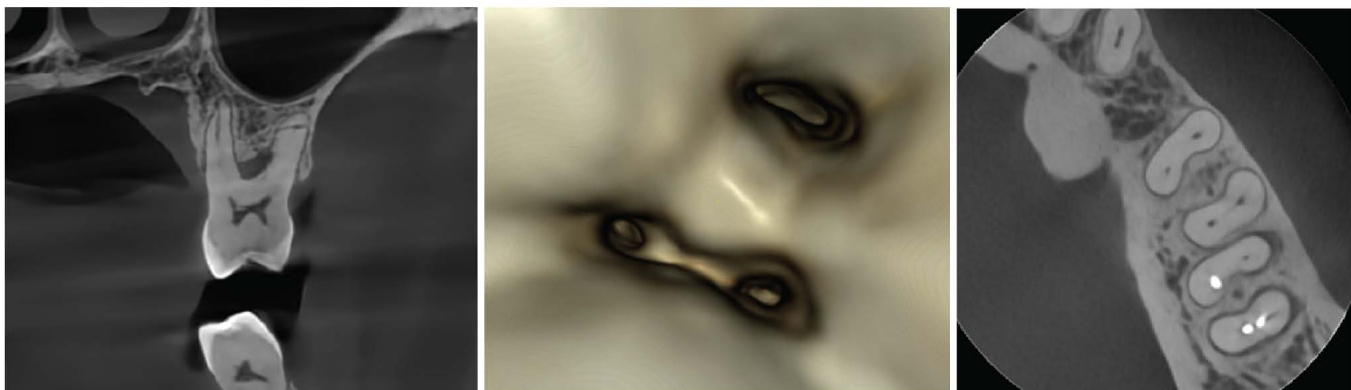

TMJ & Sleep Apnea

A comprehensive diagnostic approach to complex TMJ disorders and volumetric airway analysis for sleep apnea.



Orthodontics

Expansive FOV enables full-cranial analysis, while advanced MAR technology ensures crystal-clear imaging even with metal braces.

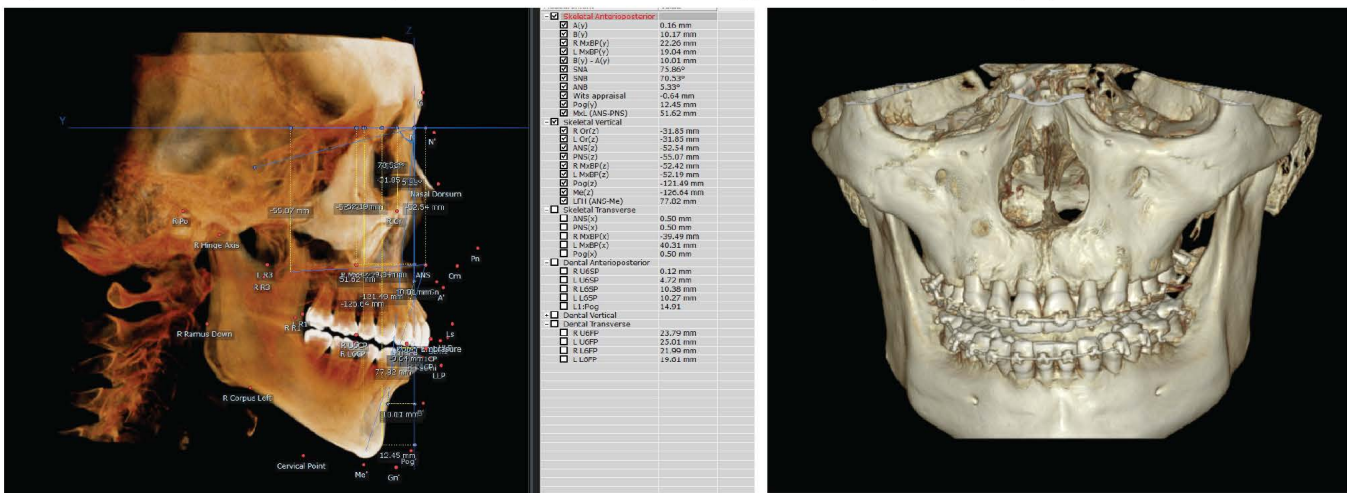

Maxillofacial Surgery

Comprehensive 3D imaging for complex orthognathic and trauma cases, with MAR to minimize scatter from surgical plates and implants.

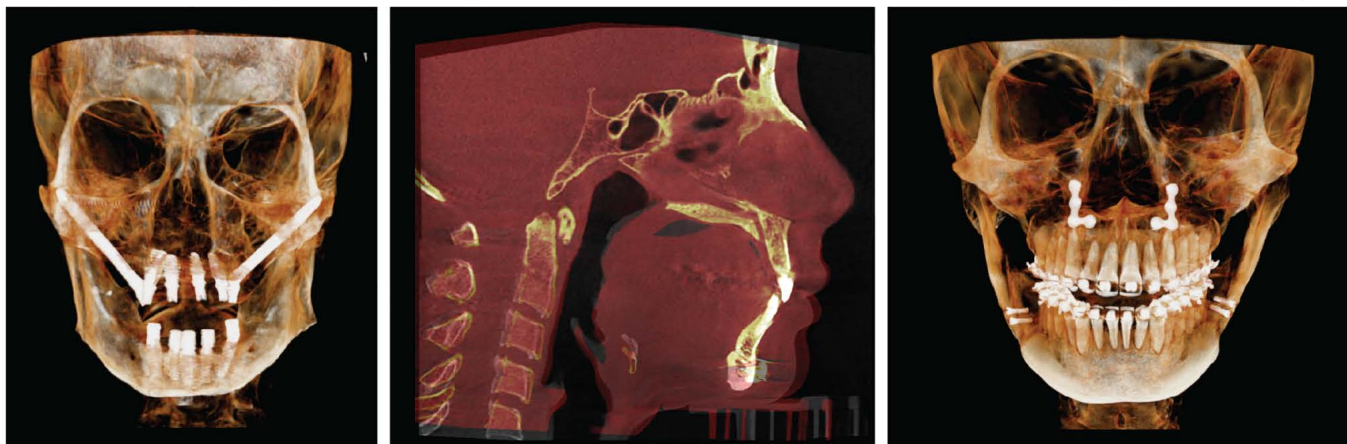

Dedicated 2D Panorama: Unmatched Clarity and Versatility

Auto Focus

Eliminate distortion and achieve crystal-clear panoramic images automatically.

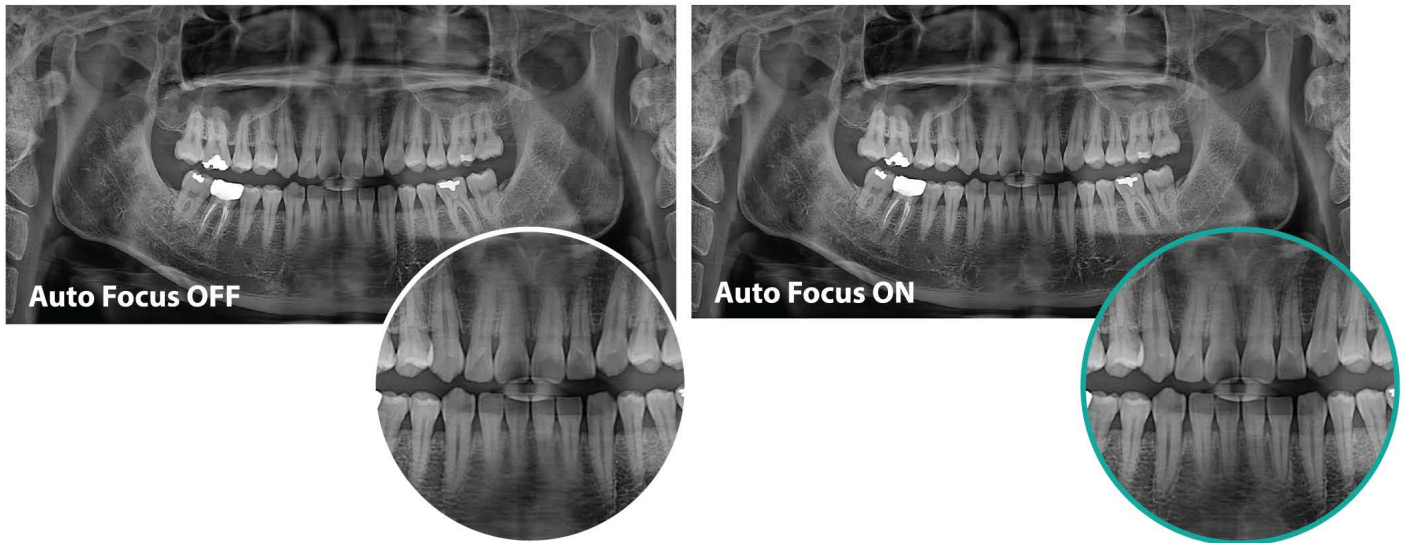

Versatile Panoramic Features

Expand your diagnostic capabilities with specialized panoramic features designed for everyday clinical efficiency.

Panoramic Options
Panorama
Bitewings (Both)
Bitewing (Left or Right)
TMJ (Both)
TMJ (Closed or Open)

Dose Settings
Adult Normal
Adult Low Dose Mode
Child Normal
Child Low Dose Mode

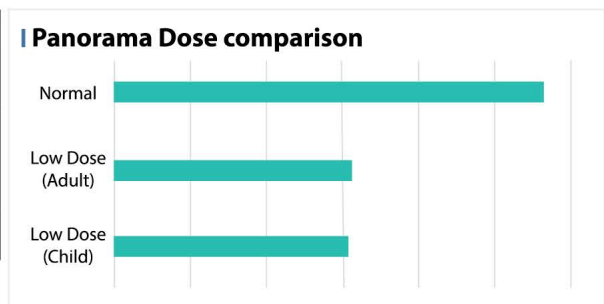

Extraoral Bitewings

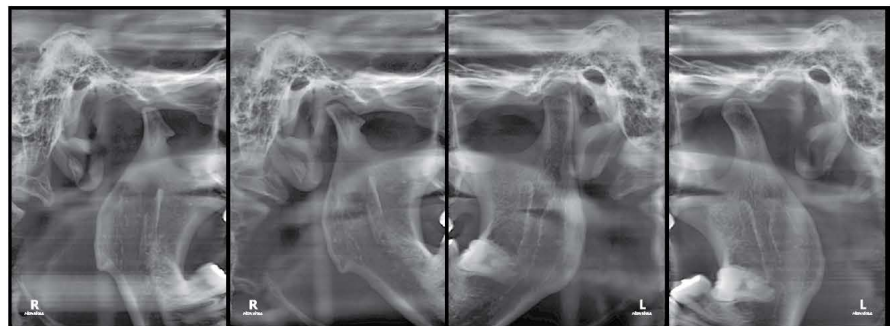

TMJ Open/Closed Views

Cephalometric X-ray



Instant Auto Landmark Tracing

Spend less time at the screen and more time with your patients.

(Available with WillCeph, the cephalometric analysis software)

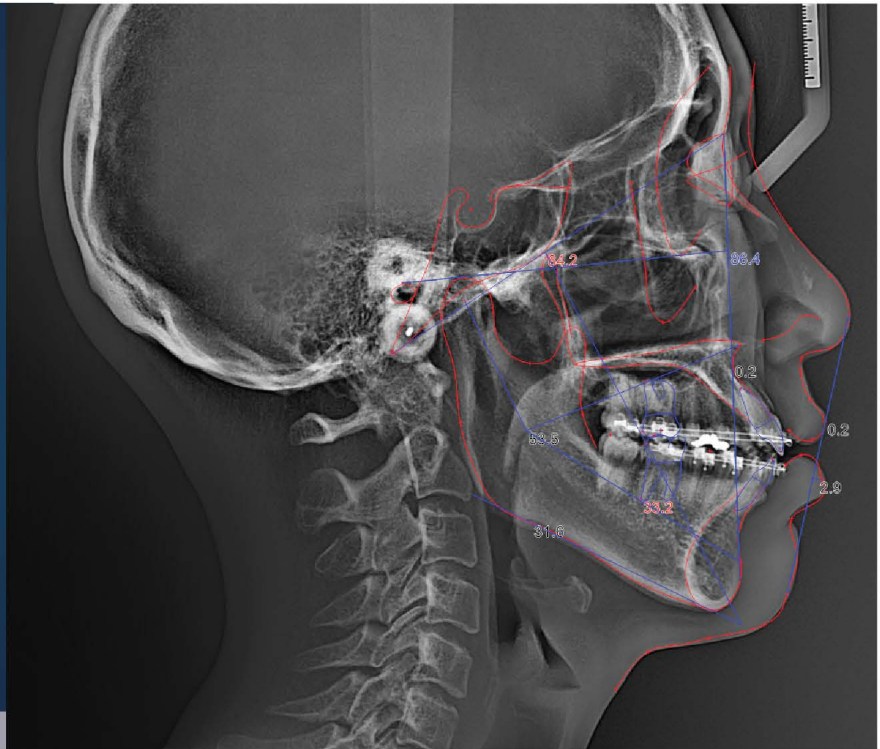

Eco-X S



Dentri S Max



✓ Premium Cephalometric Module

Delivers outstanding diagnostic clarity and precision.

- Available Models: Eco-X S, Dentri S Max
- Ultra-fast scan times starting at 3.2 seconds to minimize motion artifacts (3.2s, 4s, 6s, 8s).

✓ Various Cephalometric Features

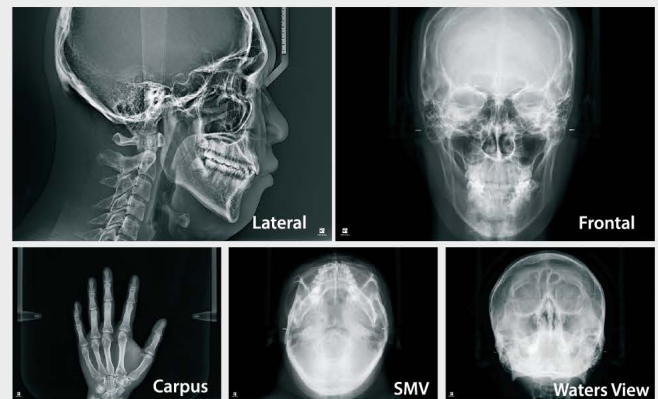

Software

WillCeph

2D cephalometric analysis software

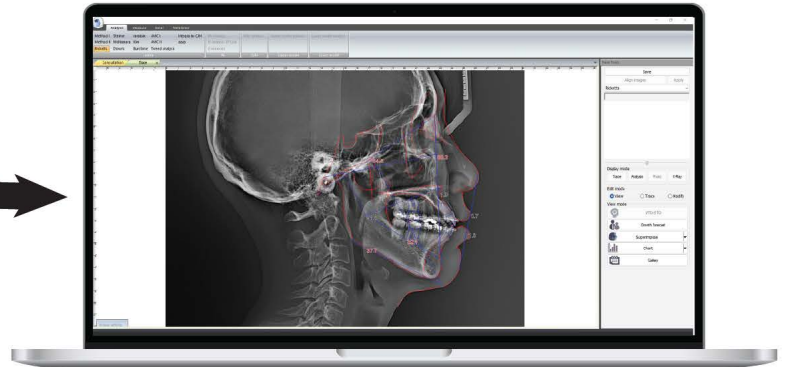

Auto Landmark Tracing

Automatic landmark tracing in seconds, dramatically reducing your analysis time.



Comprehensive Analyses

Instantly generate complete charts using standard global measurement methods (Steiner, Tweed, etc.) or personalized analyses.



Treatment Simulation

Enhance case presentation with visual morphing tools, predicting and comparing before/after facial profile changes.



Report Feature

Create personalized, professional reports with flexible gallery layouts and superimposition data for growth forecasting.



Custom Analysis Profiles

Easily build and apply your own personalized cephalometric analysis protocols.



Image Superimposition

Evaluate skeletal and soft tissue changes accurately by superimposing cephalometric images over patient photographs.

Will-Master

Patient Image Management & 2D Viewer



Will-Master streamlines your practice by intuitively managing all patient imaging data. It also includes WILL-PLAY, a built-in media library featuring educational videos to help patients visualize complex treatments and boost case acceptance.

OnDemand3D

Advanced 3D Navigation & Digital Treatment Planning

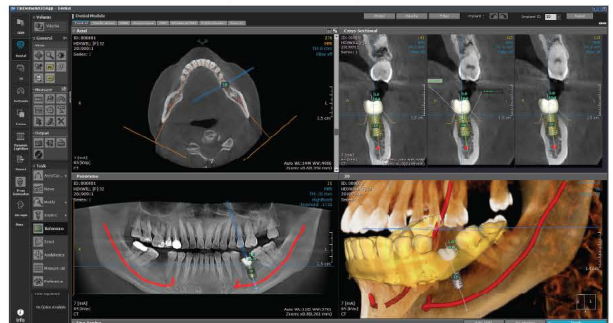

Experience ultimate diagnostic power. OnDemand3D offers robust features including digital implant planning, volumetric airway analysis, and precise 3D cephalometric analysis, catering to every clinical need in digital dentistry.

eCO Specification

Eco-X

CBCT/PANO/Model Scan
System Weight (Tolerance: 10 %): 178 kg/ 392 lbs

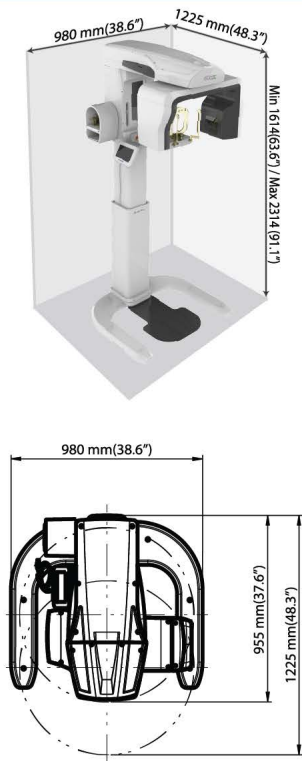

Eco-X S

CBCT/PANO/CEPH/Model Scan
System Weight (Tolerance: 10 %): 211 kg/ 465 lbs

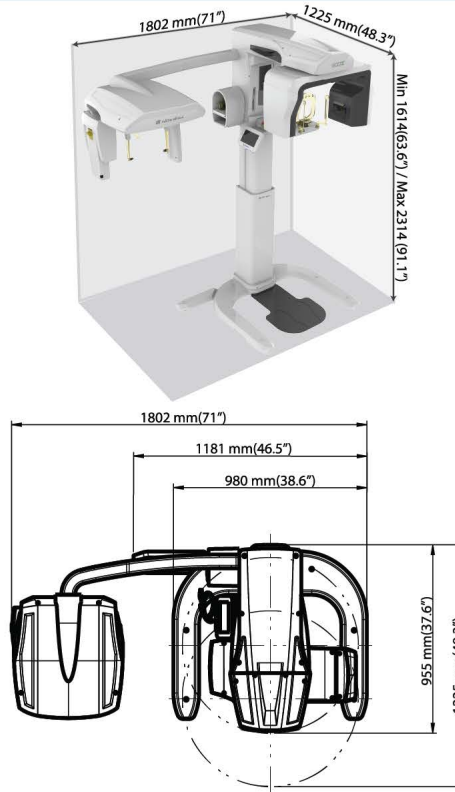

		Mode	Time
Scan Time(Adult)	CBCT		8 s or 12 s, 24 s
		Full Arch	7 s, 14 s
	PANO	Bitewings	3.2 s ~ 8 s
		TMJ	1.7 s ~ 6 s
		Lateral Large Area / Frontal(PA) / Carpus / Waters / SMV	4 s, 8 s
	CEPH	Lateral Small Area	3.2 s, 6 s
Model Scan		24 s	

Specification	
Field of View (CT) (cm × cm) (Diam. × Height)	16 × 9 or 12 × 9(Adult) 10 × 8 (Child) Free FOV (Min. 3 × 3)
Voxel Size	0.07, 0.10, 0.15, 0.20
Focal Spot (mm)	0.5
Reconstruction Time	min. 10 s (standard recon, MAR off)
Gray Scale	CT & Panorama : 16 bits Scan-type Cephalo : 14 bits
Tube Voltage	60 kV to 90 kV
Tube Current	4 mA to 10 mA
Patient Position	Standing (Wheelchair accessible)
Patient Alignment	Column: Electric motion Temple Support: Motion
Detector Type	CT & Panorama : TFT: a-Si Scan Type Cephalo : CMOS

DENTRI_{MAX} Specification

Dentri Max

CBCT/PANO/Model Scan
System Weight (Tolerance: 10 %): 243 kg / 536 lbs

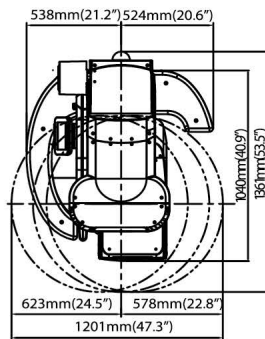
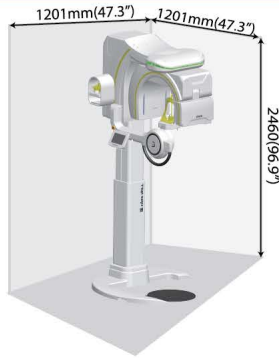

Dentri S Max

CBCT/PANO/SCAN CEPH/Model Scan
System Weight (Tolerance: 10 %): 260 kg / 573 lbs

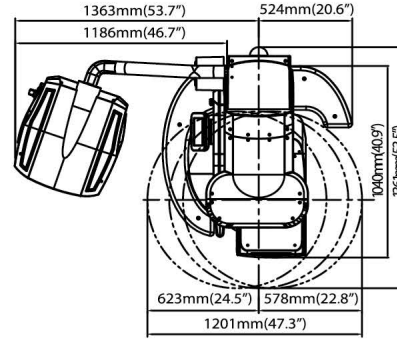
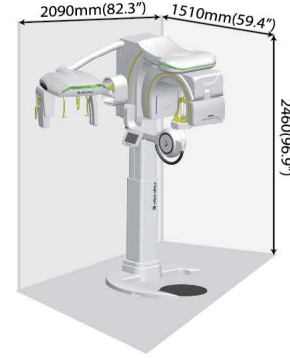

		Mode	Time
Scan Time(Adult)	CBCT	FOV 16x9 cm	8 s or 12 s, 24 s
		FOV 18x16.5 cm	16 s or 24 s, 36 s
	PANO	Full Arch	7 s, 14 s
		Bitewings	3 s - 8 s
		TMJ	1.6 s - 6 s
		Sinus	5.2 s, 10.2 s
	CEPH(Scan)	Lateral Large Area / Frontal(PA) / Carpus / Waters / SMV	4 s, 8 s
		Lateral Small Area	3 s, 6 s
Ceph(One-Shot)	One Shot	0.5 s, 1 s, 1.5 s, 2 s	
Model Scan		24 s	

Specification		
Field of View (CT) (cm × cm) (Diam. × Height)	18 × 16.5(Adult, Stitch), 16 × 9(Child, Non-Stitch) 10 × 14.5(Child, Stitch), 10 × 8(Child, Non-Stitch) Free FOV (min. 3 × 3)	
Voxel Size	0.07, 0.10, 0.15, 0.20	
Focal Spot (mm)	0.5	
Reconstruction Time	min. 10 s (standard recon, MAR off)	
Gray Scale	CT & Panorama	16 bits
	Scan & One-Shot type Cephalo	14 bits
Tube Voltage	60 kV to 90 kV	
Tube Current	4 mA to 10 mA	
Patient Position	Standing (Wheelchair accessible)	
Patient Alignment	Vertical Column: Electric motion Column: Electric motion Temple Support: Motion	
Detector Type	CT & Panorama	TFT: a-Si
	Scan Type Cephalo	CMOS
	One-Shot Type Cephalo	TFT: a-Se